

TECHNICAL DATA SHEET - **SmartMount**[®] Universal Flat Wall Mount for 37" to 60" Flat Panel Screens

peerless[®]
MOUNTS

MODELS: D-FPF-320, D-FPF-320S, SF660, SF660-S, SF660P, SF660P-S, RTFPF-320, RTFPF-320I, RTFPF-320S, RTFPF-320SI



The new SF660 delivers enhanced screen compatibility, accommodating large flat panel screens, including those with VESA[®] 800 x 400 mm hole pattern. Its open wall plate architecture allows for enhanced electrical access and cable management, as well as screen placement flexibility to achieve the perfect installation. This ultra-slim mount is the ultimate in low-profile applications for 37" to 60" flat panel screens.

Features:

- Universal mount fits screens with mounting patterns up to 32.48" W x 17.05" H
- Increased screen compatibility includes VESA[®] 800 x 400 mm mounting hole patterns
- Open wall plate architecture allows for total wall access, increasing electrical access and cable management options
- Holds screen only 1.2" from the wall for a low-profile application
- Includes deep screen adapters to hold screen 1.7" from wall for easier cable management access
- Horizontal screen adjustment of up to 8" (depending on screen model) for perfect screen placement
- Universal screen adapters easily hook onto wall plate for fast installation
- Mounts to wood studs, concrete, cinder block or metal studs (metal stud accessory required)
- Comes with Peerless' Sorted-for-You[™] fastener pack with all necessary screen attachment hardware
- Integrated security options available

Accessories:

- ACC415 - Metal Stud Fastener Kit
- SCS222 - SmartMount[®] Component Shelf

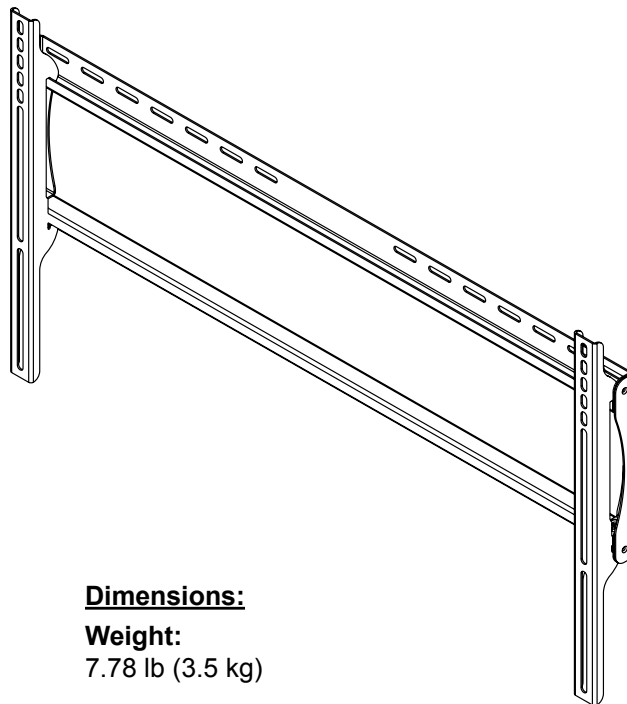

Dimensions:

Weight:

7.78 lb (3.5 kg)

Shipping weight:

9.48 lb (4.3kg)

Maximum Load Capacity:

200 lb (90.7 kg)

Shipping Carton dimensions:

SF660, SF660-S

L = 35.875 in (912 mm)

W = 10.125 in (258 mm)

H = 3.5 in (89 mm)

D-FPF-320, D-FPF-320S, SF660P, SF660P-S, RTFPF-320, RTFPF-320I, RTFPF-320S, RTFPF-320SI

L = 35.25 in (896 mm)

W = 10.063 in (256 mm)

H = 3.5 in (89 mm)

ARCHITECTS SPECIFICATIONS

The **Smartmount[®] Universal Flat Wall Mount** be a Peerless model _____ and shall be located where indicated on the plans. It shall be constructed of heavy gauge cold rolled steel and finished with scratch resistant Black or Silver Fused Epoxy. Assembly and installation shall be done according to instructions provided by the manufacturer.

Peerless Industries, Inc.

3215 W. North Ave. Melrose Park, IL 60160
708-865-8870 800-865-2112 Fax 708-865-2941

www.peerlessmounts.com

ISSUED: 01-16-07 SHEET NO: 202-9565-3 09-11-08

© 2008, Peerless Industries, Inc. All rights reserved.
All other brand and product names are trademarks or registered trademarks of their respective owners.

TECHNICAL DATA SHEET

MODELS: D-FPF-320, D-FPF-320S, SF660, SF660-S, SF660P, SF660P-S, RTFPF-320, RTFPF-320I, RTFPF-320S, RTFPF-320SI

All dimensions = inch (mm)

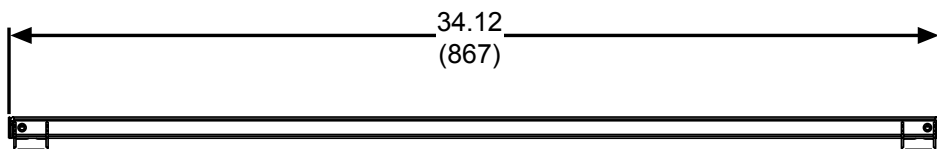

Top View

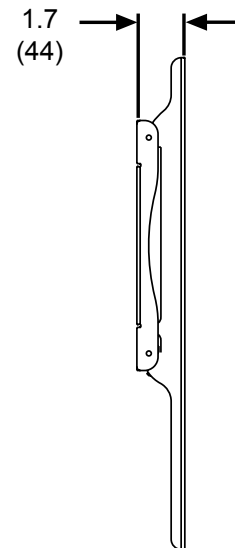

Side View with Deep Adapter Bracket

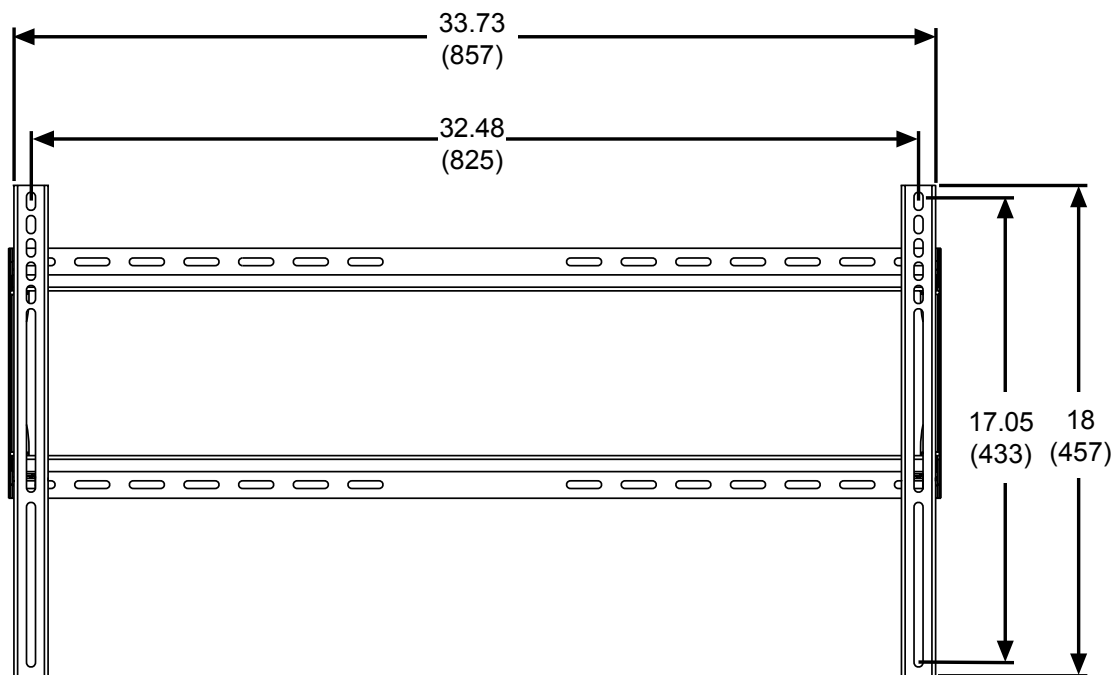

Front View

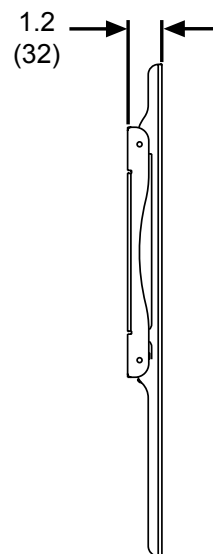

Side View with Shallow Adapter Bracket

TECHNICAL DATA SHEET

MODELS: D-FPF-320, D-FPF-320S, SF660, SF660-S, SF660P, SF660P-S, RTFPF-320, RTFPF-320I, RTFPF-320S, RTFPF-320SI

All dimensions = inch (mm)

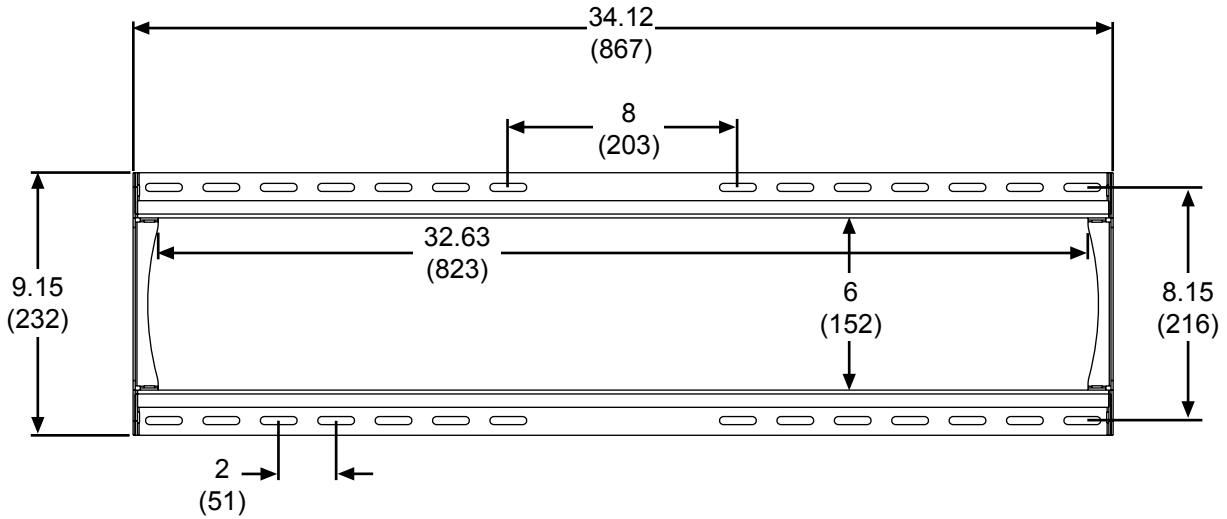

Wall Plate Detail

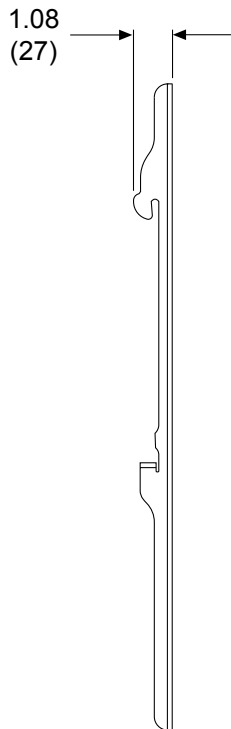

Shallow Adapter Bracket Detail

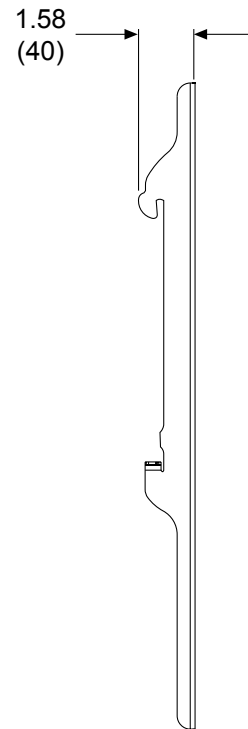

Deep Adapter Bracket Detail